

236



DDSD1352

Installation and operation instruction V1.0

ACREL Co.,Ltd

Declare

The copyright is the property of Acrel. Any information in any paragraph or section cannot be extracted, copied or otherwise reproduced or propagated. Otherwise offenders shall take all consequences.

All rights are reserved.

Acrel reserves the right to modify the product specifications herein without notification. Please consult the local agent about the latest specifications before placing a purchase order

Content

1	Overview.....	- 1 -
3	Technical parameter.....	- 1 -
4	Overall dimensions (unit: mm).....	- 2 -
5	Wiring and installing.....	- 3 -
6	Operation and display.....	- 4 -
7	Communication description.....	- 8 -

1 Overview

DDSD1352 single phase electric meter is designed for single phase active energy measurement on low voltage system, in the same time it can measure the electrical parameters like voltage, current, power and so on. There is also RS485 can be chosen. This power meter has advantages of smaller volume, high precision, good EMC, easily installing etc, All meters meet the related technical requirements of electronic power meter in the IEC62053-21、IEC62053-22 standards.

2 Function

Function	Function description	Function provide
Measurement of kWh	Single-phase active kWh (positive and negative)	■
Measurement of electrical parameters	Voltage, Current, Active power, Reactive power, Apparent power, Power factor and Frequency	■
LCD Display	8 bits section LCD display	■
Key programming	3 keys to set parameters like code, address, baud rate, multi-tariff and communication protocol	■
Pulse output	Active energy pulse output	■
Multi-tariff	Adapt 4 time zones, 2 time interval lists, 14 time interval by day and 4 tariff rates	□F
Communication	Communication interface: RS485, Communication protocol: MODBUS-RTU	□C
	Infrared communication	■

(■: means standard; □: means optional)

3 Technical parameter

3.1 Electric performance

Input voltage	Reference voltage	AC 220V
	Reference frequency	50Hz
	Power consumption	<10VA
Input current	Basic current	10A,20A(External transformer)
	Maximum current	60A,100A(External transformer)
	Starting current	4%I _b
	Consumption	<4VA (Maximum current)
Measurement	Accuracy of	1class

performance	measuring	
	Range of measuring	000000.00~99999999kWh
Clock accuracy		Error \leq 0.5s/d
Active pulse	Pulse width	80 \pm 20ms
	Pulse constant	1600imp/kWh , 800imp/kWH(corresponding to basic current), LED
Communication	Interface	RS485(A+, B-)
	Connection mode	Shielded twisted pair conductors
	Protocol	MODBUS-RTU

3.2 Mechanical performance

Outline (Length \times Width \times Height)	88mm \times 36mm \times 70mm
---	----------------------------------

3.3 Work environment

Temperature range	Work temperature	-25 $^{\circ}$ C~55 $^{\circ}$ C
	Storage Temperature	-40 $^{\circ}$ C~70 $^{\circ}$ C
Relative humidity		\leq 95%(No condensation)
Altitude		<2000m

4 Overall dimensions (unit: mm)

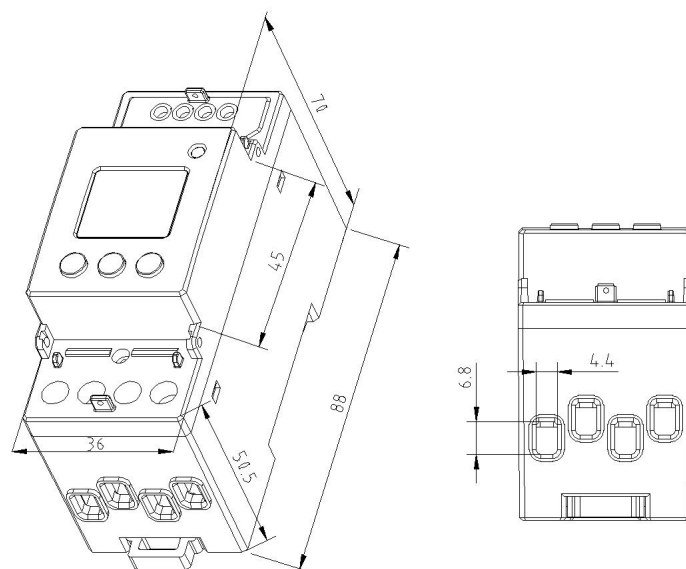

Instrument dimensions

Note: The torque should not be greater than 2.0N·m

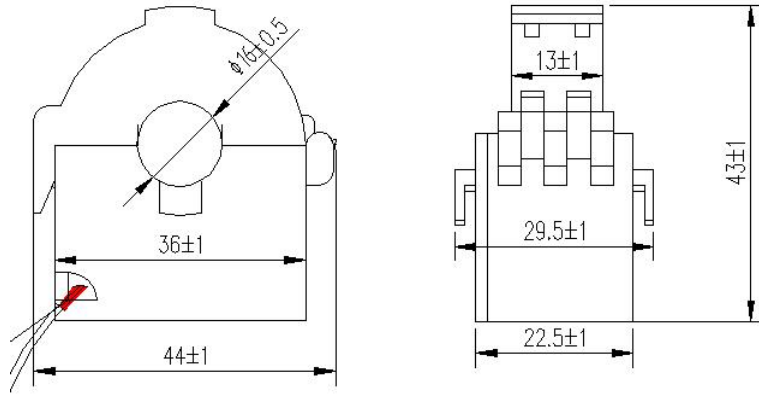

External transformer dimensions

5 Wiring and installing

5.1 Wiring instructions

The DDS1352-CT uses a current transformer for access.

Remark:

1. DDS1352-CT external transformer is red and white two wires, red instrument I+, white instrument I-;

2. DDS1352-CT uses its own mA class transformer, it is strictly forbidden to access ordinary 5A or 1A output transformer, otherwise it will cause damage to the instrument;

3. DDS1352-CT When wiring, the transformer terminals are prohibited from shorting and grounding, otherwise it will lead to inaccurate metering or instrument damage;

4. When the DDS1352-CT is used to measure the secondary line of the field transformer, the instrument's own transformer should be kept at a distance (greater than 30cm) from the field primary side transformer to avoid interference.

5.2 Schematic diagram of voltage and current wiring



10 (60) A

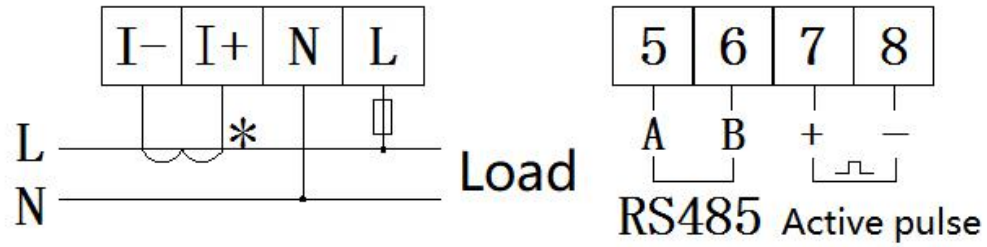

20 (100) A

Tips:DDSD1352 single phase electric meter used the direct connecting method. Please pay attention to the direction of input and output while wiring and screw tightly, prevent the meter from the abnormal work.

6 Operation and display









6.1 Key description

Key Icon	Key name	Key function
	Menu	Enter/quit, save
	Up	Flash bit change
	Down	Flash bit right-ward/next page

6.2 Display of measurement menu









Show total energy when connected. Change information while pressing down key. Display information as following:

<p>(1) Total active energy</p>	<p>(2) Voltage</p>
<p>(3) Current</p>	<p>(4) Active power</p>
<p>(5) Reactive power</p>	<p>(6) Apparent power</p>





 (7) Power factor	 (8) Frequency
 (9) Version of software	 (10) Date
 (11) Time	 (12) Spike energy
 (13) Peak energy	 (14) Flat energy
 (15) Valley energy	









Note: There are no (10)(11)(12)(13)(14)(15)when multi-tariff function (F) is not applied.

6.3 Programming display menu

Press  at any main menu and get in  interface, and then press  show , and enter the code. If you enter a wrong code, it will show  and back to main menu; and if you enter a right code, you can set the parameter. After setting the parameter, it will show  and save the change by pressing  and quit without save by pressing .

6.3.1 Item can be set

Num	Firstly Menu		Secondly menu		
	Symbol	Meaning	Symbol	Meaning	Range
1		Code		Set code	0000-9999
2		(modbus)		Set address (modbus)	1-247

3		Baud rate		Set baud rate	9600 、 4800 、 2400、 1200
4		Multi-tariff		Set multi-tariff	No/Yes
4		Parity method		Set parity method	None/Even/Odd
6		Save		Save page	No/Yes

6.3.2 Key setting process

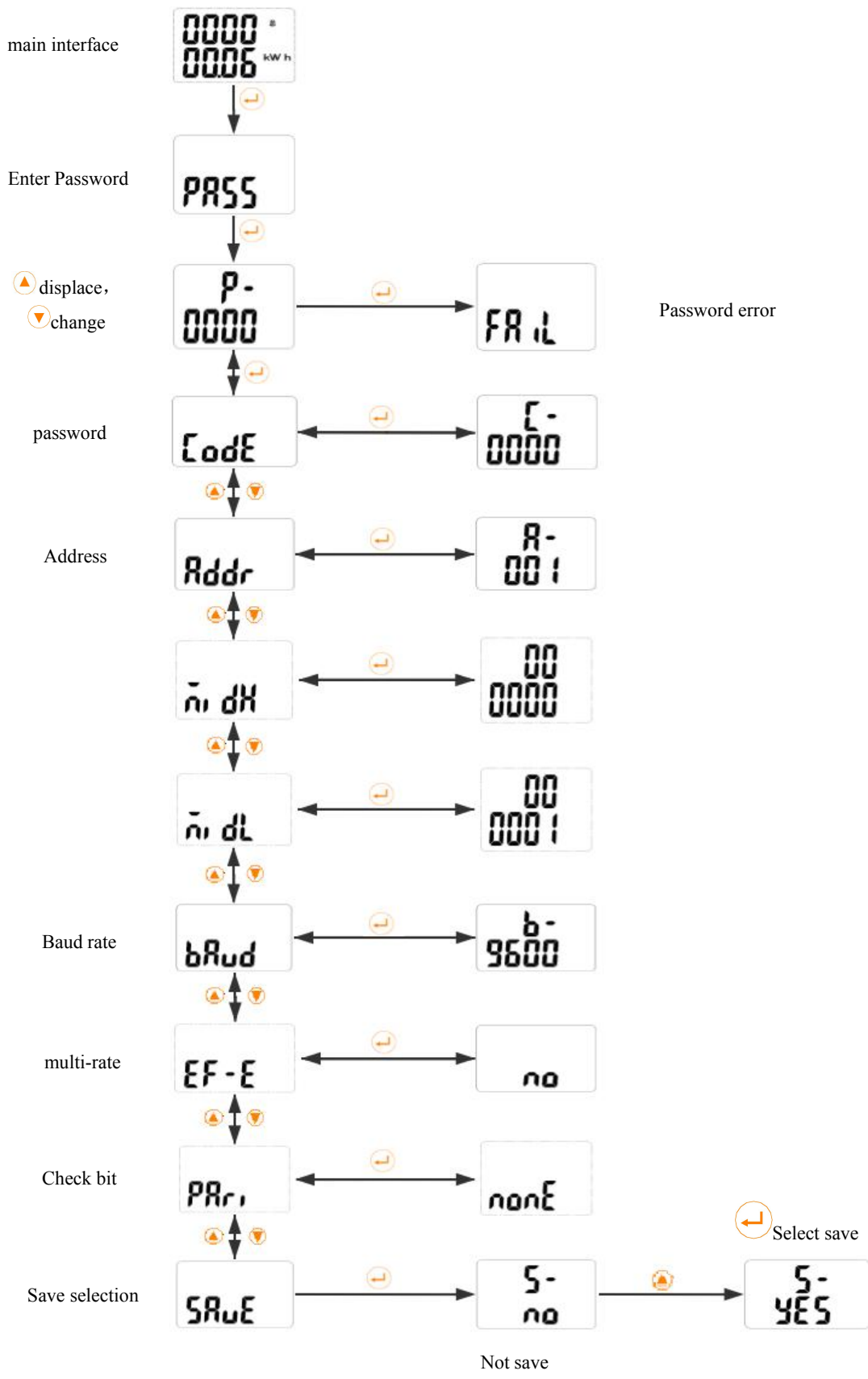

7 Communication description

7.1 Communication protocol

The meters adapt Modbus . Please refer to the relevant standards for more information. The multi-tariff data mean nothing when multi-tariff function (F) is not applied.

7.2 MODBUS Address list

Address	Variable	Length	R/W	Notes
0000H	Current total energy	4	R	
0001H				
0002H	Current spike energy	4	R	
0003H				
0004H	Current peak energy	4	R	
0005H				
0006H	Current flat energy	4	R	
0007H				
0008H	Current valley energy	4	R	
0009H				
000AH	Code	2	R/W	
000BH	U Voltage	2	R	
000CH	I Current	2	R	
000DH	P Active power	2	R	
000EH	Q Reactive power	2	R	
000FH	S Apparent power	2	R	
0010H	PF Power factor	2	R	
0011H	Frequency	2	R	
0012H	Year, month	2	R/W	
0013H	Day, hour	2	R/W	
0014H	Minute, second	2	R/W	
0015H high	Address	1	R/W	1~247
0015H low	Communication baud rate	1	R/W	Baud Rate: 1:9600 2:4800 3:2400 4:1200
0016H 0021H	Reserve			
0022H	Total electric energy of last month	4	R	
0023H				

0024H	Spike electric energy of last month	4	R	
0025H				
0026H	Peak electric energy of last month	4	R	
0027H				
0028H	Flat electric energy of last month	4	R	
0029H				
002AH	Valley electric energy of last month	4	R	
002BH				
002CH	Total electric energy of last 2 month	4	R	
002DH				
002EH	Spike electric energy of last 2 month	4	R	
002FH				
0030H	Peak electric energy of last 2 month	4	R	
0031H				
0032H	energy of last 2 month	4	R	
0033H				
0034H	Valley electric energy of last 2 month	4	R	
0035H				
0036H	Total electric energy of last 3 month	4	R	
0037H				
0038H	Spike electric energy of last 3 month	4	R	
0039H				
003AH	Peak electric energy of last 3 month	4	R	
003BH				
003CH	Flat electric energy of last 3 month	4	R	
003DH				
003EH	Valley electric energy of last 3 month	4	R	
003FH				
0040H ... 0047H				
0048H	Test method	2	R	0000 None 0002 Even
0049H ... 0067H	Reserved			
0068H	Current forward active total energy	4	R	
006AH	Current forward active spike energy	4	R	
006CH	Current forward active peak energy	4	R	
006EH	Current forward active flat energy	4	R	
0070H	Current forward active valley energy	4	R	

0072H	Current reversing active total energy	4	R	
0074H	Current reversing active spike energy	4	R	
0076H	Current reversing Active peak energy	4	R	
0078H	Current reversing active flat energy	4	R	
007AH	Current reversing Active valley energy	4	R	
007CH ... 0081H	4 time zones	3 × 4	R/W	
0082H ... 0096H	14-period of time Parameters setting information	3 × 14	R/W	The first time list
0097H ... 00ABH	14-period of time Parameters setting information	3 × 14	R/W	The second time list

Headquarters: Acrel Co., LTD.

Address: No.253 Yulv Road Jiading District, Shanghai, China

TEL.: 0086-21-69158338 0086-21-69156052 0086-21-59156392
0086-21-69156971

Fax: 0086-21-69158303

Web-site: www.acrel-electric.com

E-mail: ACREL008@vip.163.com

Postcode: 201801

Manufacturer: Jiangsu Acrel Electrical Manufacturing Co., LTD.

Address: No.5 Dongmeng Road, Dongmeng industrial Park, Nanzha
Street, Jiangyin City, Jiangsu Province, China

TEL: 0086-510-86179966

Fax: 0086-510-86179975

Web-site: www.jsacrel.com

Postcode: 214405

E-mail: sales@email.acrel.cn